

NAVSHIPS 94200.4-2 Directory of Electronics Test
Equipment - Supplement 2
Section 4.2 Frequency Measuring Equipment

USA

USN

USAF

TYPE CLASS:

Used by

MANUFACTURER'S NAME/CODE NUMBER: Babcock Electronics Corporation, (82050).

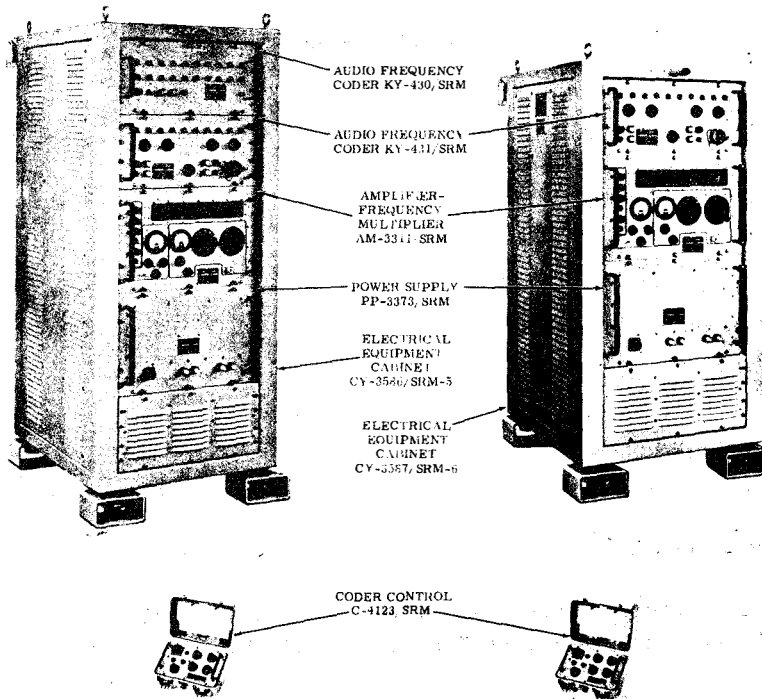

TEST SET TARGET CONTROL SYSTEM AN/SRM-5

FUNCTIONAL DESCRIPTION:

Test Set Target Control System AN/SRM-5 provides facilities to test the performance of components of the Target Control System AN/SRW-4 (Series). The AN/SRM-5 Test Set supplies frequency-modulated UHF signals that simulate the command signals which are normally used to control either fixed or rotary wing drone aircraft. The control signals generated by the AN/SRM-5 Test Set are used to simulate the command signals of the Target Control System AN/SRW-4 (Series) so that the performance of the components being tested may be analyzed either with the normal receiver monitoring portion of the system or through the monitoring functions provided by the Target Control System Test Set AN/SRM-3.

No field changes in effect at time of preparation (19 October 1965).

RELATION TO OTHER EQUIPMENT: None.

EQUIPMENT REQUIRED BUT NOT SUPPLIED: None.

4.2 AN/SRM-5: 1

TARGET SET TARGET CONTROL SYSTEM AN/SRM-5

TECHNICAL CHARACTERISTICS:

OPERATING DATA

SIGNAL GENERATOR

RANGE: 406 to 549.5 mc.

OUTPUT: 1.0 uv to 100,000 uv.

EXTERNAL MODULATION: 0 to 300 kc dev.

POWER REQUIREMENTS: 115 v ac, 60 cps, single ph.

MAJOR COMPONENTS

QTY	ITEM	STOCK NUMBERS	DIMENSIONS (INCHES)	WEIGHT (LBS)
1	Test Set Target Control System AN/SRM-5 includes:		24-5/8 x 34-7/8 x 55-3/32	769
1	Audio Frequency Coder KY-430/SRM		8-3/4 x 19 x 23	75
1	Audio Frequency Coder KY-431/SRM		8-3/4 x 19 x 23	60
1	Amplifier Frequency Multiplier AM/3311/SRM		12-1/4 x 19 x 23	75
1	Power Supply PP-3373/SRM		12-1/4 x 19 x 23	110
1	Electrical Equipment Cabinet CY-3586/SRM-5		24-5/8 x 28 x 55-3/32	449
1	Coder Control C-4123/SRM		8 x 8 x 10-1/2	9-1/2

31

REFERENCE DATA AND LITERATURE:

NAVWEPS 16-30SRM5-1: Handbook Operation and Service Instructions with Illustrated Parts Breakdown for Target Control System Test Set AN/SRM-5.

TUBE, CRYSTAL AND/OR SEMI-CONDUCTOR DATA:

TUBES: (1) 5R4WGE (2) 6C4WA (18) 5814A (2) 0B2WA (1) 5725/2D21W (3) 6AH6WA
 (1) 5726/6AL5W (4) 6AN5W (8) 6AU6WB (2) 6BC4 (2) 5721/12AX7 (2) 5842
 (1) 5670 (5) 5963 (5) 6703 (15) 6922 (5) B5092 (4) GC10D (1) DA2WA
 (3) 6080WB

CRYSTALS: Not required.

SEMI-CONDUCTORS: (108) 1N251 (13) 1N540 (2) 1N645 (5) 1N752A (1) 1N757A
 (4) 1N1124A (4) 1N1614 (2) 1N1733 (1) 1N2984B (2) 1N3005B
 (1) 1N3014B (1) 1N3039B (39) 1N3070 (1) 10Z6.2TS (4) 2N297A
 (4) 2N335 (2) 2N526 (4) 2N1039 (1) 2N1120

SHIPPING DATA

PKGS	VOLUME (CU FT)	WEIGHT (LBS)
1	4.2 AN/SRM-5: 2	800

TEST SET TARGET CONTROL SYSTEM AN/SRM-5

PROCUREMENT DATA

PROCURING SERVICE: USN
SPEC &/OR DWG:

DESIGN COG: USN, BuWeps

CONTRACTOR	LOCATION	CONTRACT OR ORDER NO.	APPROX. UNIT COST
Babcock Electronics Corp. Pt. No. 111141	Costa Mesa, California	N0w 60-0658	

32

10 December 1965
Cog Service: USN

FSN:

TEST SET TARGET CONTROL SYSTEM AN/SRM-6
Functional Class:

USA

USN

USAF

TYPE CLASS:

Used by

MANUFACTURER'S NAME/CODE NUMBER: Babcock Electronics Corporation, (82050).

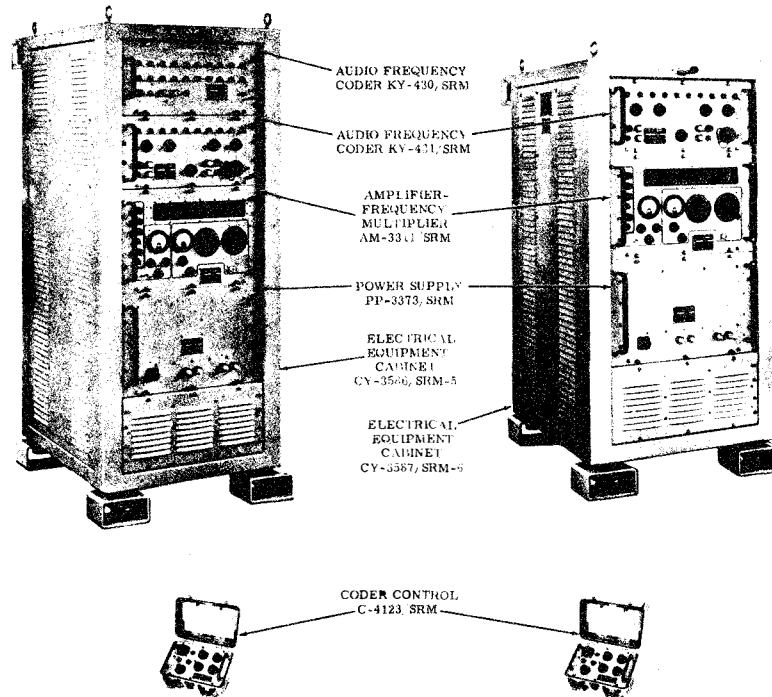

TEST SET TARGET CONTROL SYSTEM AN/SRM-6

FUNCTIONAL DESCRIPTION:

Test Set Target Control System AN/SRM-6 provides the facilities to simulate operations performed by various components of the Target Control System AN/SRW-4B (DASH) to ascertain proper operation or perform fault isolation. The AN/SRM-6 test set supplies frequency modulated uhf signals that simulate the command signals that are used to control rotary wing drone aircraft so that the performance of the components being tested may be analyzed. Performance monitoring may be accomplished with either the normal receiver portion of the system or through the monitoring functions provided by the Target Control System Test Set AN/SRM-4.

No field changes in effect at time of preparation (19 October 1965).

RELATION TO OTHER EQUIPMENT:

This set is used with, but is not a part of the Target Control System AN/SRW-4 series.

TEST SET TARGET CONTROL SYSTEM AN/SRM-6

EQUIPMENT REQUIRED BUT NOT SUPPLIED: None.

TECHNICAL CHARACTERISTICS:

OPERATING DATA

SIGNAL GENERATOR

RANGE: 406 to 549.5 mc.

OUTPUT: 1.0 uv to 100,000 uv.

EXTERNAL MODULATION: 0 to 300 kc dev.

POWER REQUIREMENTS: 115 v ac, 60 cps, single ph.

MAJOR COMPONENTS

QTY	ITEM	STOCK NUMBERS	DIMENSIONS (INCHES)	WEIGHT (LBS)
1	Test Set Target Control System AN/SRM-6 includes:		24-5/8 x 34-7/8 x 53-13/16	628
1	Audio Frequency Coder KY-431/SRM		8-3/4 x 19 x 23	60
1	Amplifier Frequency Multiplier AM-3311/SRM		12-1/4 x 19 x 23	75
1	Power Supply PP-3373/SRM		12-1/4 x 19 x 23	110
1	Electrical Equipment Cabinet CY-3587/SRM-6		24-5/8 x 34-7/8 x 46-11/32	383
1	Coder Control C-4123/SRM		8 x 8 x 10-1/2	9-1/2

REFERENCE DATA AND LITERATURE:

NAVWEPS 16-30SRM-5-1: Handbook Operation and Service Instructions with Illustrated Parts Breakdown for Target Control System Test Set AN/SRM-6.

TUBE, CRYSTAL AND/OR SEMI-CONDUCTOR DATA:

TUBES: (1) 5R2WGE (5) 5963 (2) 6C4WA (5) 6703 (18) 5814A (15) 6922 (2) 0B2WA
 (5) 85092 (1) 5725/2D21W (4) GC10D (3) 6AH6WA (1) DA2WA (1) 5726/6AL5W
 (3) 6080WB (4) 6AN5W (8) 6AV6WB (2) 6BC4 (2) 5721/12AX7 (2) 5842 (1) 5670

CRYSTALS: Not required.

SEMI-CONDUCTORS: (108) 1N251 (1) 10Z6.2TS (4) 2N297A (13) 1N540 (2) 1N645
 (4) 2N335 (5) 1N752A (2) 2N526 (1) 1N757A (4) 2N1039
 (4) 1N1124A (1) 2N1120 (4) 1N1614 (2) 1N1733 (1) 1N2984B
 (2) 1N3005B (1) 1N3014B (1) 1N3039B (39) 1N3070

SHIPPING DATA

PKGS	VOLUME (CU FT)	WEIGHT (LBS)
1		628

4.2 AN/SRM-6: 2

TEST SET TARGET CONTROL SYSTEM AN/SRM-6

PROCUREMENT DATA

PROCURING SERVICE: USN
SPEC &/OR DWG:

DESIGN COG: USN, BuWeps

CONTRACTOR	LOCATION	CONTRACT OR ORDER NO.	APPROX. UNIT COST
Babcock Electronics Corp. Pt/Dwg No. 111454	Costa Mesa, California	NOW 60-0658	

35

28 October 1964

TEST SET, RADAR AN/UPM-119

Cog Service: USN FSN:

Functional Class:

USA

USN

USAF

TYPE CLASS:

Used by

MANUFACTURER'S NAME/CODE NUMBER: Sperry Microwave Electronics Co., Div. of Sperry Rand Corp., (06424).

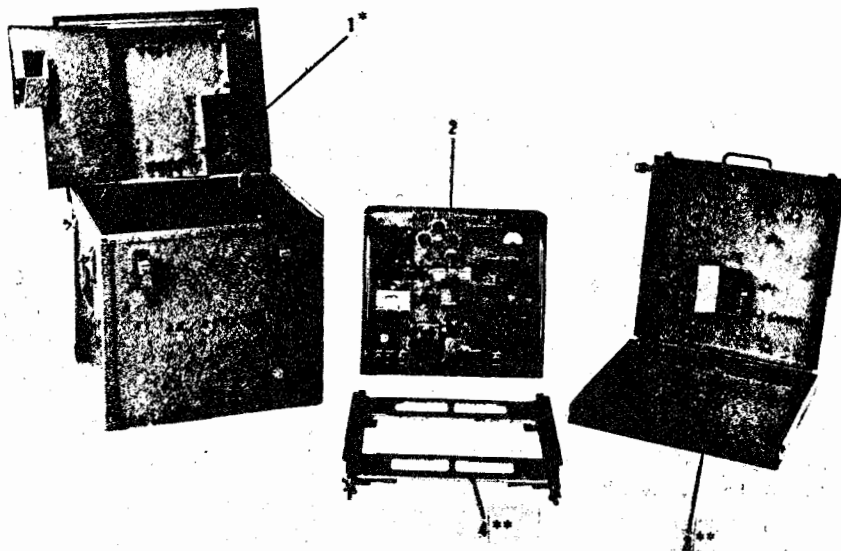

TEST SET, RADAR AN/UPM-119

FUNCTIONAL DESCRIPTION:

Test Set, Radar AN/UPM-119 is a portable unit designed for testing and adjusting radar systems operating in the frequency range of 32,600 to 33,800 megacycles. It combines in one test set all the functions of three conventionally separate units: an fm test set, a spectrum analyzer, and a synchroscope. This latter feature eliminates the necessity for an external oscilloscope in the normal use of the test set.

Applications in which the test set finds major use include the following: (a) Measurement of the radar transmitted power and frequency; (b) Measurement of radar receiver local oscillator frequency, bandwidth, sensitivity and recovery time; (c) Tuning of radar local oscillators; (d) Performance tests and/or tuning of duplexers, afc systems, rotating joints etc; (e) Visual observation of the spectra of magnetrons, klystrons, local oscillators, test sets, and other equipment within the test set frequency range; (f) Investigation of magnetron pulling.

No field changes in effect at time of preparation (2 October 1964).

AN/UPM-119 TEST SET, RADAR

RELATION TO OTHER EQUIPMENT:

This equipment is similar to the AN/UPM-14 except it covers the frequency range of 34 to 35.6 kilomegacycles.

EQUIPMENT REQUIRED BUT NOT SUPPLIED:

TECHNICAL CHARACTERISTICS:

FM GENERATOR

FREQUENCY

RANGE: 32.6 to 33.8k mc.

ABSOLUTE ACCURACY: ± 10 mc at 25° C ($+77^{\circ}$ F) and 60% relative humidity; ± 20 mc from -20 to $+40^{\circ}$ C (-4 to 104° F) and relative humidities from 0 to 95%.

ACCURACY WITH INDIVIDUAL CALIBRATION CURVE: ± 10 mc from -40 to $+55^{\circ}$ C (-40 to $+131^{\circ}$ F) and relative humidities from 0 to 95%.

POWER OUTPUT

RANGE: -25 to -100 dbm at rf output connector.

ACCURACY: ± 2 db of overall calibration chart from -20 to $+40^{\circ}$ C (-4 to $+104^{\circ}$ F) and relative humidities from 0 to 95%.

FREQUENCY MODULATION

DEVIATION: 1 to 60 mc.

PHASE: 2 to 50 usec after trigger.

REPETITION RATE: 400 to 4000 cps.

AMPLITUDE: 0 to 240 v.

SLOPE: 2 v per usec.

DC LEVEL AT REFLECTOR: -50 to -200 v.

TRIGGER AMPLIFIER GAIN: Approx.

EXTERNAL MODULATION: Any signal whose peak amplitude is less than 200 v.

TRIGGERS REQUIRED FOR SAWTOOTH SWEEP GENERATOR

RF TRIGGER: 50 to 1000 W peak, 0.1 to 2 usec pulses, prf 400 to 4000 pps.

VIDEO TRIGGER: $+10$ to $+50$ v, peak 0.1 to 2 usec pulses, prf 400 to 4000 pps.

POWER INPUT

RANGE: $+10$ to $+30$ dbm.

ACCURACY: ± 2 db with correction chart.

SPECTRUM ANALYZER

TUNING RANGE: 32.6 to 33.8k mc.

SPECTRUM SWEEP RATE: 3 to 30 cps, 0 to 170 v.

ATTENUATION: $+10$ to $+30$ dbm.

IF BANDWIDTH: 30 kc.

CW SENSITIVITY: 50 to 60 db below 1 mw for 1 in. CRT deflection.

SYNCHROSCOPE

DEFLECTION SENSITIVITY: 1 v per in.

SWEEP SPEEDS: 5, 20, 50, 250 and 4000 usec.

BANDPASS: 6 mc.

PULSE GENERATOR

REPETITION RATES: 100 to 4000 pps.

DELAY: 1 to 4000 usec.

POWER REQUIREMENTS: 115 v ac $\pm 10\%$, 50 to 800 cps, 1 ph, 300 W.

4.2 AN/UPM-119: 2

MAJOR COMPONENTS

QTY	ITEM	STOCK NUMBERS	DIMENSIONS (INCHES)	WEIGHT (LBS)
1	Test Set, Radar AN/UPM-119 in- cludes:		15-15/16 x 16-15/16 x 18-7/8	75
1	Case Test Set CY-3166/UPM-119			
1	Case Accessories CY-3165/UPM-119			
1	Mounting MT-2528/UPM-119			
1	Test Antenna AT-159/U			
2	RF Cable Assy CG-1433/U		96 lg	
2	Waveguide Assy CG-2210/UPM-119			
1	Cable Assy CX-3277/U			
2	Fuse 3 AG			
2	Adapter, Waveguide UG-1414/UPM-119			
1	Crystal Diode 1N53			
1	Wrench		0.050 x 1-3/4	
1	Incandescent Lamp			
1	Wrench		0.062 x 1-3/4	
1	Wrench		0.078 x 1-7/8	

REFERENCE DATA AND LITERATURE:

NAVSHIPS 94182: Technical Manual for Radar Test Set AN/UPM-119.

TUBE, CRYSTAL AND/OR SEMI-CONDUCTOR DATA:

TUBES: (1) VA-97B (2) 5R4WGA (1) 6AQ5 (7) 5814A (2) 5651 (5) 6111 (1) 5639
 (3) 5654 (1) 5725/6AS6W (1) 12AT7WA (1) 6D4 (3) 5687 (3) 5751 (5) 6AH6
 (1) 6AU6WA (1) 1Z2 (1) 6X4 (1) 6080WA (3) 0A2WA (1) 3KP1

CRYSTALS: Not required.

SEMI-CONDUCTORS: (2) 1N53 (4) 1N127A

SHIPPING DATA

PKGS	VOLUME (CU FT)	WEIGHT (LBS)
1	8	145

AN/UPM-119 TEST SET, RADAR

PROCUREMENT DATA

PROCURING SERVICE: USN
SPEC &/OR DWG:

DESIGN COG: USN, BuShips

CONTRACTOR	LOCATION	CONTRACT OR ORDER NO.	APPROX. UNIT COST
Sperry Microwave Elec- tronics Company, Divi- sion of Sperry Rand Corporation	Clearwater, Florida	N0bsr-81278	

39

2 August 1965

TEST SET RADIO AN/URM-143(XN-1)

Cog Service: USN FSN:

Functional Class:

USA

USN

USAF

TYPE CLASS:

Used by

MANUFACTURER'S NAME/CODE NUMBER: Northeastern Engineering Incorporated, (80667).

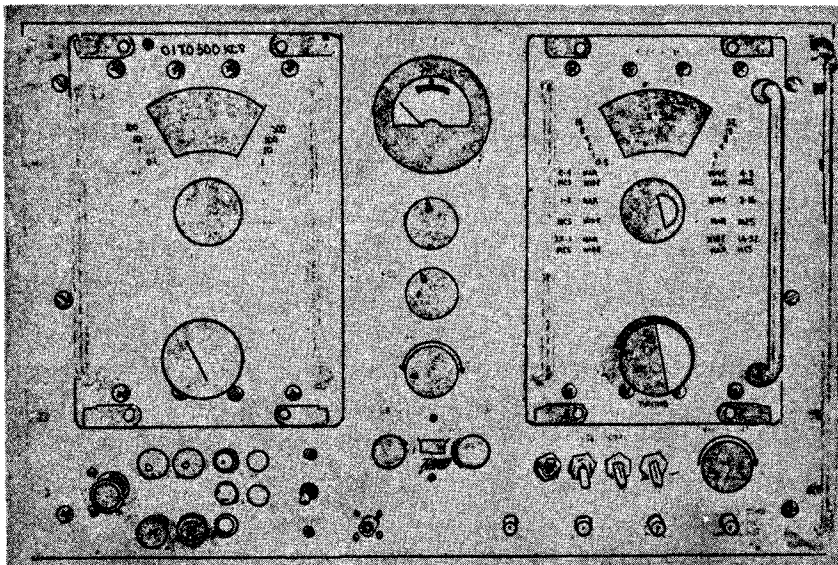

TEST SET RADIO AN/URM-143(XN-1)

FUNCTIONAL DESCRIPTION:

Test Set, Radio AN/URM-143(XN-1) provides either continuous wave or frequency swept signals for test purposes. It may be used to provide the signal source for visually aligning narrow band communications equipment, checking the band pass characteristics of amplifiers or filters on other similar testing.

No field changes in effect at time of preparation (14 June 1965).

RELATION TO OTHER EQUIPMENT: None.

EQUIPMENT REQUIRED BUT NOT SUPPLIED:

(1) Oscilloscope CBTV 545A.

40

TEST SET RADIO AN/URM-143(XN-1)

TECHNICAL CHARACTERISTICS:

FREQUENCY RANGE: 0.1 to 500 kc.

TUNING BANDS: 0.1 to 1 kc.
10 to 100 kc.
100 to 500 kc.

FREQUENCY RANGE: 0.5 to 32 mc.

TUNING BANDS: 0.5 to 1 mc.
1 to 2 mc.
2 to 4 mc.
4 to 8 mc.
8 to 16 mc.
16 to 32 mc.

FREQUENCY CONTROL: Manual control of center frequency with automatic electronic control of sweep.

TYPE OF EMISSION

- (a) Continuous wave.
- (b) Narrow frequency-adj from ± 0.1 to $\pm 2.5\%$ of center frequency.
- (c) Tide frequency sweep-adj from ± 1 to $\pm 25\%$ of center frequency.

ATTENUATION: Adj in 10 db and 1 db steps from 0 to 129 db.

AUXILIARY OUTPUTS

MARKER PULSE

FREQUENCY: 1 mc, 100 kc, and/or 10 kc.

SWEEP OUTPUT: Saw tooth wave form for horizontal input to oscilloscope.

ACCURACY AND STABILITY

CW-SHORT TERM FREQUENCY STABILITY: 0.005%.

NARROW SWEEP: Sweep linear to $\pm 10\%$ over range.

TIDE SWEEP: Sweep linear to $\pm 15\%$ over range.

MARKER PULSE: Freq accurate to 0.0005%.

DIAL ACCURACY: $\pm 12\%$ over range, both tuning units.

INPUT POWER REQUIREMENTS: 115 v $\pm 10\%$ ac, 50-450 cyc, single ph.

MAJOR COMPONENTS

QTY	ITEM	STOCK NUMBERS	DIMENSIONS (INCHES)	WEIGHT (LBS)
1	Test Set Radio AN/URM-143(XN-1) includes:		12-7/32 x 18-9/16 x 19	75
2	Detector Assy		1 x 4	0.5
1	Power Cable		6 lg	0.5
4	RF Cable			3.5

REFERENCE DATA AND LITERATURE:

NAVSHIPS 94960: Technical Manual for Radio Test Set AN/URM-143(XN-1).

TUBE, CRYSTAL AND/OR SEMI-CONDUCTOR DATA:

TUBES: (1) 6688 (12) 6922 (1) 2D21 (2) 0B2 (1) 6AK5 (1) 6080WA (2) 12AV7

CRYSTALS: (1) CR-27/U

TEST SET RADIO AN/URM-143(XN-1)

SEMI-CONDUCTORS: (12) 1N487 (17) 1N459 (1) 1N1805 (8) HC-7005 (4) HC-7008 (2) F-4
(4) VR-12 (2) V-15 (4) V-20 (2) A100271

SHIPPING DATA

PKGS	VOLUME (CU FT)	WEIGHT (LBS)
1	2.8	100

PROCUREMENT DATA

PROCURING SERVICE: USN DESIGN COG: USN, BuShips
SPEC &/OR DWG: SHIPS-G-3587

CONTRACTOR	LOCATION	CONTRACT OR ORDER NO.	APPROX. UNIT COST
Northeastern Engineering Incorporated	Manchester, New Hampshire	N0bsr 81561	

9 November 1964

WAVEMETER AN/USM-54

Cog Service: USN FSN:

Functional Class:

USA

USN

USAF

TYPE CLASS:

Used by

MANUFACTURER'S NAME/CODE NUMBER: Sperry Gyroscope Co., (56232).

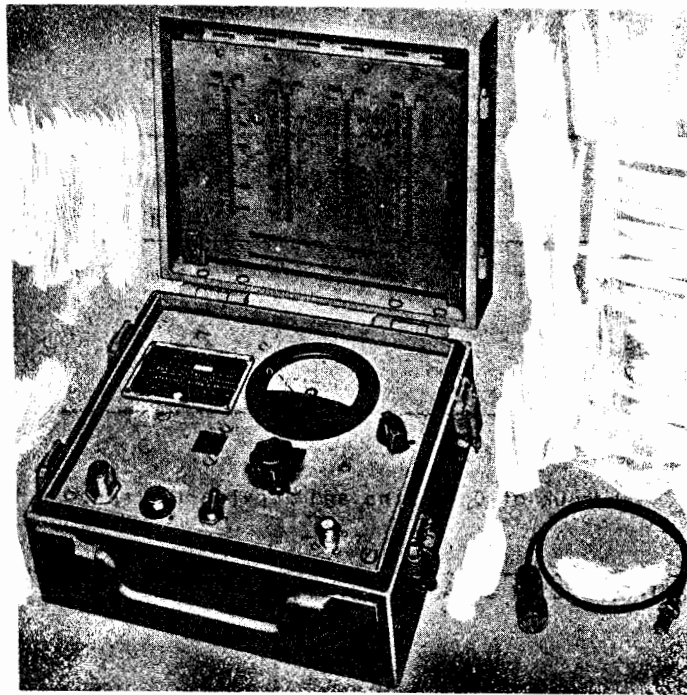

WAVEMETER AN/USM-54

FUNCTIONAL DESCRIPTION:

Wavemeter AN/USM-54 is a portable, general purpose equipment use to indicate the frequency of an RF signal. Maximum needle deflection indicates that the meter is tuned to resonance. Tuning and sensitivity are adjusted by means of control knobs. A vernier dial in conjunction with a serialized conversion chart provided with the meter, indicates the frequency that the meter is tuned.

No field changes in effect at time of preparation (30 October 1964).

RELATION TO OTHER EQUIPMENT:

The AN/USM-54 is similar to Frequency Meter Sperry 537.

AN/USM-54 WAVEMETER

EQUIPMENT REQUIRED BUT NOT SUPPLIED:**TECHNICAL CHARACTERISTICS:**

FREQUENCY RANGE: 3500 to 6500 mc, accuracy 0.1%.
TYPE OF FREQUENCIES MEASURED: Modulated and cw.
LOADED Q: 400.
INPUT IMPEDANCE: 50 ohms.
MICROAMMETER: 0 to 50 ua; scale is in 50 graduations.

MAJOR COMPONENTS

QTY	ITEM	STOCK NUMBERS	DIMENSIONS (INCHES)	WEIGHT (LBS)
1	Wavemeter AN/USM-54 includes:		5-3/4 x 9-1/2 x 10-1/4	
1	Wavemeter FR-95/USM-54			
1	RF Cable Assy CG-1372/U		25	
2	Spare Crystals 1N21B			

REFERENCE DATA AND LITERATURE:

NAVWEPS 16-30USM54-501: Handbook of Operating and Service Instructions for Wavemeter AN/USM-54.

TUBE, CRYSTAL AND/OR SEMI-CONDUCTOR DATA:

TUBES: Not required.

CRYSTALS: Not required.

SEMI-CONDUCTORS: (2) 1N21B

SHIPPING DATA

PKGS	VOLUME (CU FT)	WEIGHT (LBS)
------	----------------	--------------

PROCUREMENT DATA

PROCURING SERVICE: USN
SPEC &/OR DWG:

DESIGN COG: USN, BuWeps

4.2 AN/USM-54: 2

CONTRACTOR	LOCATION	CONTRACT OR ORDER NO.	APPROX. UNIT COST
Sperry Gyroscope Co.	Great Neck, N. Y.		

15

24 November 1964

TEST SET, RADIO FREQUENCY POWER AN/USM-174

Cog Service: USN FSN: 2F6625-964-9677

Functional Class:

USA

USN

USAF

TYPE CLASS:

Used by

MANUFACTURER'S NAME/CODE NUMBER: Paradyamics Inc., (95924).



TEST SET, RADIO FREQUENCY POWER AN/USM-174

FUNCTIONAL DESCRIPTION:

Test Set, Radio Frequency Power AN/USM-174 is a portable, lightweight unit, designed to measure average pulsed power in the frequency range of 0.1 to 26.0K mc.

No field changes in effect at time of preparation (12 November 1964).

RELATION TO OTHER EQUIPMENT:

EQUIPMENT REQUIRED BUT NOT SUPPLIED:

AN/USM-174 TEST SET, RADIO FREQUENCY POWER AN/USM-174

TECHNICAL CHARACTERISTICS:

INPUT FREQUENCY RANGE: 0.1 to 26K mc.
METER RANGE: 0 to 38 mw; 0 to 3.8 w; - 10 to + 35 dbm.
ACCURACY: ± 1 db.
ZERO DRIFT: 1% of full scale in 10 sec.
STABILITY: 1% of full scale in 10 sec.
VSWR: 1.25 max.
OPERATING TEMPERATURE: $- 28^{\circ}$ to 65° C ($- 18.4^{\circ}$ to 117.0° F).
POWER REQUIRED: 12 v dc (nickel-cadmium battery).
BATTERY CHARGING SOURCE
ALTERNATE OPERATING SOURCE: 105 to 125 v, 50 to 440 cps, single ph.

MAJOR COMPONENTS

QTY	ITEM	STOCK NUMBERS	DIMENSIONS (INCHES)	WEIGHT (LBS)
1	Test Set, Radio Frequency Power AN/USM-174 includes: RF Power Output Test Set Unit Cover Unit Assembly CW-669/USM-174	2F6625-964-9677	7-1/4 x 9-1/4 x 12-3/4	16
1	Cable Assembly Power MS2548		72	
1	Cable Assembly, Special Purpose CX8467/USM-174		72	
1	Bolometer, Radio Frequency DT-272/USM-174		1 x 3	
1	Probe Waveguide MX-4651/USM-174		1-5/8 x 3-3/16 x 3-13/64	
1	Probe Waveguide MX-4652/USM-174		1-7/16 x 3-39/64 x 3-15/16	
1	Probe Waveguide MX-4653/USM-174		1-7/16 x 1-29/32 x 3-7/16	
1	Attenuator Fixed CN-912/USM-174		7/8 x 5-3/32	
1	Attenuator Fixed CN-913/USM-174		7/8 x 5-51/64	
1	Attenuator Fixed CN-914/USM-174		1-5/8 x 1-5/8 x 8-5/64	
1	Attenuator Fixed CN-915/USM-174		1-5/16 x 1-5/16 x 7-3/4	
1	Attenuator Fixed CN-916/USM-174		7/8 x 7/8 x 7-11/16	

REFERENCE DATA AND LITERATURE:

NAVSHIPS 94948: Technical Manual for RF Power Output Test Set AN/USM-174.

TUBE, CRYSTAL AND/OR SEMI-CONDUCTOR DATA:

TUBES: Not required.

CRYSTALS: Not required.

SEMI-CONDUCTORS: (6) 1N645 (2) 1N751A (8) 2N43A (3) 2N1039

4.2 AN/USM-174: 2

5 November 1964

TEST SET, ANTENNA AN/WLM-2

Cog Service: USN FSN: 2F6625-856-1774

Functional Class:

USA

USN

USAF

TYPE CLASS:

Used by

MANUFACTURER'S NAME/CODE NUMBER: Thompson Ramo Wooldridge Inc., (59875).

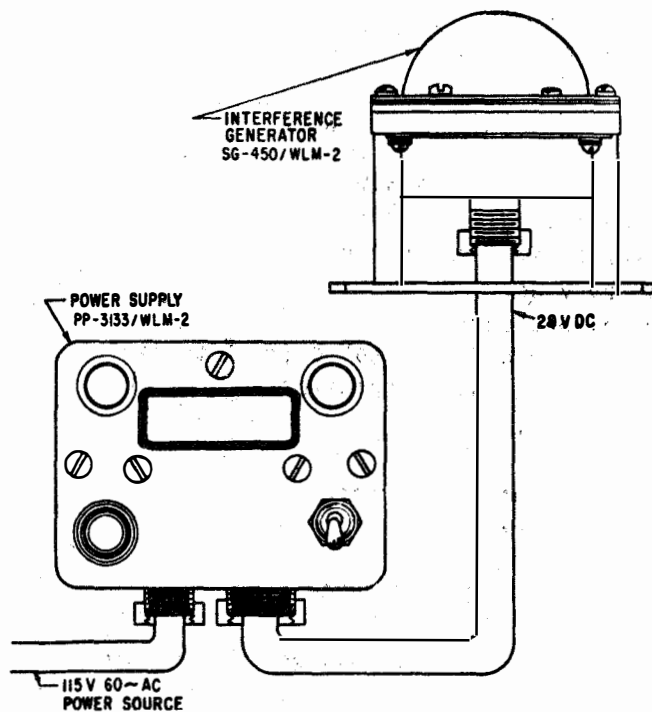

TEST SET, ANTENNA AN/WLM-2

FUNCTIONAL DESCRIPTION:

Test Set, Antenna AN/WLM-2 consists of an Interference Generator SG-450/WLM-2, and a Power Supply PP-3133/WLM-2. The Interference Generator SG-450/WLM-2 can be permanently mounted in the vicinity of a specific antenna or group of antennas in radomes of submarines or on surface vessels. It can be energized from a remote location by the permanently mounted Power Supply PP-3133/WLM-2. When energized, the buzzer (DS-201) in Interference Generator SG-450/WLM-2 will generate radio frequency noise. The effects of this radiation can be heard or seen at the output of the receiver associated with the antenna, if the system is operating satisfactorily. The equipment is for use as an operability check of the antenna system and give a relative check of the quality of performance of the antenna system.

No field changes in effect at time of preparation (27 October 1964).

AN/WLM-2 TEST SET, ANTENNA

RELATION TO OTHER EQUIPMENT:**EQUIPMENT REQUIRED BUT NOT SUPPLIED:**

(1) Technical Manual for Countermeasures Receiving Set AN/WLR-1 NAVSHIPS 93442; (1) Technical Manual for Countermeasures Receiving Set AN/WLR-3 NAVSHIPS 93139A; (1) Technical Manual for Countermeasures Receiving Set AN/BLR-1 NAVSHIPS 91973; (1) Mounting Bracket (fabricated) for Power Supply PP-3133/WLM-2; (AR) Cable, Shielded, Heavy Duty Type 1450, manufactured by Alfa Wire Corporation, New York, N. Y. (approximately 75 feet required).

TECHNICAL CHARACTERISTICS:

FREQUENCY RANGE: 150 kc to 10,000 mc min band.

TYPE OF EMISSION: Radio frequency noise.

INTERFERENCE GENERATOR SG-450/WLM-2 OPERATING CHARACTERISTICS

OPERATING VOLTAGE: 26 to 29 v dc.

OPERATING CURRENT: 40 ma direct current.

AMBIENT TEMPERATURE LIMITATIONS: - 40° to + 50° C (-40° to 122° F).

POWER SUPPLY PP-3133/WLM-2 OPERATING CHARACTERISTICS

INPUT VOLTAGE: 115 v ac, 60 cyc.

OUTPUT VOLTAGE: 26 to 29 v dc.

INPUT CURRENT: 35 ma max alternating current.

OUTPUT CURRENT: 40 ma direct current.

MAJOR COMPONENTS

QTY	ITEM	STOCK NUMBERS	DIMENSIONS (INCHES)	WEIGHT (LBS)
1	Test Set, Antenna AN/WLM-2 includes:	2F6625-856-1774		
1	Interference Generator SG-450/WLM-2 (includes) Mount Support		3-3/4 x 3-3/4 x 3-11/64	1
1	Power Supply PP-3133/WLM-2		3-1/2 x 3-13/16 x 4-11/64	1-1/2
1	Publications Package (each includes)		1/2 x 8-1/2 x 11	1/2
2	Complementary Technical Manual		1/2 x 8-1/2 x 11	
2	Field Change Bulletin Information Sheet		8-1/2 x 11 8-1/2 x 11	

REFERENCE DATA AND LITERATURE:

NAVSHIPS 94290: Complementary Technical Manual for Antenna Test Set AN/WLM-2.

4.2 AN/WLM-2: 2

TUBE, CRYSTAL AND/OR SEMI-CONDUCTOR DATA:

TUBES: Not required.

CRYSTALS: Not required.

SEMI-CONDUCTORS: (1) 1N539

SHIPPING DATA

PKGS	VOLUME (CU FT)	WEIGHT (LBS)
1	44.6	1
2	55.7	1-1/2
3	46.8	1/2

PROCUREMENT DATA

PROCURING SERVICE: USN

DESIGN COG: USN, BuShips

SPEC &/OR DWG: MIL-T-21901 Amend 2

CONTRACTOR	LOCATION	CONTRACT OR ORDER NO.	APPROX. UNIT COST
Thompson Ramo Wooldridge Inc.	Cleveland, Ohio	NObsr 85212	

23 April 1965

Cog Service: USN FSN: 2F6625-072-5839

COUNTER, FREQUENCY, ELECTRONICS CP-778/U

Functional Class:

USA

USN

USAF

TYPE CLASS:

Used by

MANUFACTURER'S NAME/CODE NUMBER: Northeastern Engineering, Inc., (80667).

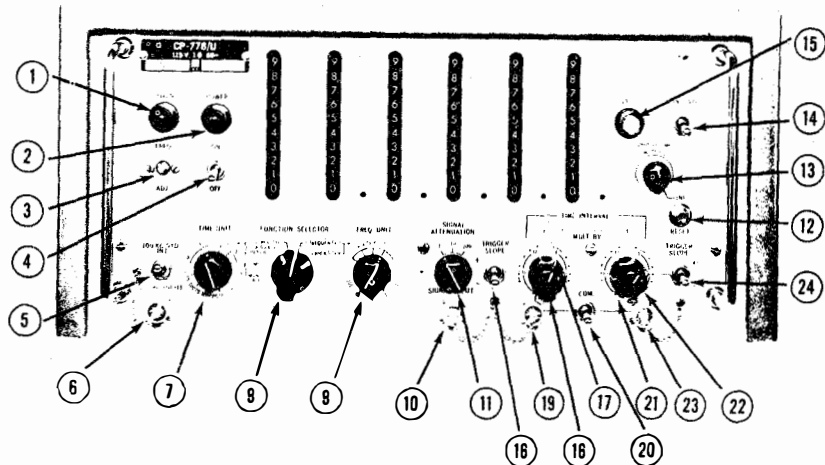

COUNTER, FREQUENCY, ELECTRONICS CP-778/U

FUNCTIONAL DESCRIPTION:

Counter, Frequency, Electronics; CP-778/U is a precision, direct-reading instrument capable of measuring frequency, period, time and frequency ratio, frequency drift and of totalizing discreet electrical impulses of regular or random occurrence. This instrument may also be used as a secondary frequency standard with outputs of 1 cps, 10 cps, 100 cps, 1 kc, 10 kc, and 100 kc. This counter has a self-check feature that provides quick checks on many of the instrument's circuits. This type counter has outstanding characteristics not found in similar units: (1) Wide range of coverage: frequencies up to 120 kc, time intervals up to 100,000 seconds and period measurements up to 100 kc; (2) Automatic Decimal Point Placement: no further calculation or interpolation is necessary; (3) Instantaneous use: instruments stand-by condition keeps the oscillator at operating temperature.

No field changes in effect at time of preparation (29 March 1965).

COUNTER, FREQUENCY, ELECTRONICS CP-778/U

RELATION TO OTHER EQUIPMENT: None.

EQUIPMENT REQUIRED BUT NOT SUPPLIED: None.

TECHNICAL CHARACTERISTICS:

FREQUENCY MEASUREMENT

RANGE: 10 to 120 kc.
INPUT IMPEDANCE: 1 megohm shunted by 20 to 40 uuf.
INPUT SENSITIVITY: 0.1 v rms min.
ACCURACY: ± 1 count, \pm crystal stability.
STANDARD GATE TIME: 0.001, 0.01, 0.1, 1 and 10 seconds.
READOUT: 6 digits in cycles per second or kilocycles with automatic decimal point placement.

PERIOD MEASUREMENT

RANGE: 0 to 100 kc.
ACCURACY: $\pm 0.3\%$ \pm stability for sine waves of 0.5 v rms and 40 db signal-to-noise ratio.
GATE TIME: 1 to 10 cycles of unknown freq w/provision to extend freq by manual control.
STANDARD FREQUENCIES (TIME UNIT SWITCH): 1 cps, 10 cps, 100 cps, 1 kc, 10 kc and 100 kc and external.
READOUT: 6 places in seconds or milliseconds.

TIME INTERVAL MEASUREMENT

RANGE: 1 usec to 100,000 sec.
START AND STOP CHANNELS: Driven by common or separate inputs positive or negative polarity may be selected for either channel.
INPUT SENSITIVITY: 1 v peak min.
INPUT IMPEDANCE: 1 meg shunted by 20 to 40 uuf.
TRIGGER LEVEL (EACH CHANNEL): - 192 to + 192 v.
ACCURACY: 6 digits in kc w/automatic decimal point placement.
STANDARD FREQUENCIES (TIME UNIT SWITCH): 0 to 100 kc.
STABILITY STANDARD OSCILLATOR: 1 pt in 10^6 short time; 2 pt in 10^6 per week.
DISPLAY TIME: Variable from 0.1 to 10 sec, also indefinite hold.
POWER REQUIREMENTS: 115 v, 50 to 60 cps, 340 W (can be rewired for 250 v service).

MAJOR COMPONENTS

QTY	ITEM	STOCK NUMBERS	DIMENSIONS (INCHES)	WEIGHT (LBS)
1	Counter Frequency Electronics CP-778/U	2F6625-072-5839	8-3/4 x 16-1/4 x 19	45

REFERENCE DATA AND LITERATURE:

NAVSHIPS 95763: Frequency Counter Model 13-10CA Electronic Frequency Counter CP-778/U.

TUBE, CRYSTAL AND/OR SEMI-CONDUCTOR DATA:

TUBES: (5) 5654/6AK5W (6) 5725/6AS6W (1) 5727/2D21 (1) 5844 (15) 5963 (1) 5965
(1) 6080WA (2) 6AU6WA (1) 6BC7 (1) 6C4 (1) 6U8A (2) 12AT7 (1) 0B2WA

4 August 1965
Cog Service: USN FSN:

CAVITY, TUNED FR-150/UP
Functional Class:

USA

USN

USAF

TYPE CLASS:

Used by

MANUFACTURER'S NAME/CODE NUMBER: Johnson Service Co., (32242).

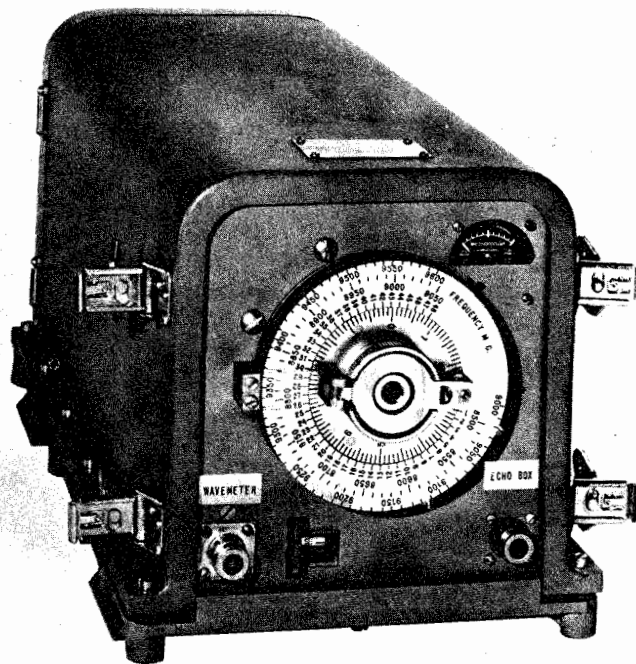

CAVITY, TUNED FR-150/UP

FUNCTIONAL DESCRIPTION:

Cavity, Tuned FR-150/UP is a portable echo box designed to permit the convenient testing of radars in the frequency range of 8500 to 9600 mc. When properly used this echo box is helpful in recognizing and localizing troubles. It should be used daily to measure the "ring-time" of the radar, and if the measured value is less than that predicted for the particular radar by more than 300 yards, the radar should be repaired. The echo box consists of a hand tuned resonator of high Q, excited by means of a flexible cable which is connected to the RF test point of the radar. A transient oscillation is induced in the cavity by the radar pulse. As long as this oscillation lasts, a signal is fed back to the radar receiver. The time required for this signal to become imperceptible on the radar indicator is called the "ring-time", and is usually expressed in yards or meters of radar range. The ringtime is a day-to-day, or relative, measure of the performance of the radar transmitter and receiver combined. This measured value may be compared to a value predicted in the technical manual of the echo box, to find out whether the performance of the radar is up to standard. A meter attached to

CAVITY, TUNED FR-150/UP

the box yields a rough relative measure of the output of the transmitter alone. Additional valuable tests can be made with this echo box.

This echo box differs from previous echo boxes in that it is necessary to set the echo box dial to the approximate frequency of the radar before searching for resonance with the echo box dial. If the frequency of the radar is not known it can be determined with a small wavemeter located on the echo box panel. Wavemeter resonance is indicated on the echo box meter.

No field changes in effect at time of preparation (21 June 1965).

RELATION TO OTHER EQUIPMENT:

This equipment is capable of performing the function of all other echo boxes operating within the frequency range of 8500 to 9600 mc. Some previous echo boxes each of which covered but a portion of this band, include the TS-311/UP, TS-218/UP, TS-488/UP, and the TS-62/AP.

EQUIPMENT REQUIRED BUT NOT SUPPLIED: None.

TECHNICAL CHARACTERISTICS:

FREQUENCY RANGE: 8500 to 9600 mc in two ranges, 8500 to 9050 mc and 9010 to 9600 mc.

RESONANT FREQUENCY CONTROL: Manually tuned by knob. No band switching required.

ELECTRICAL INPUT: 50 ohm type RG-9A/U cable w/type N plugs. The power is derived from the directional coupler of the radar.

TEMPERATURE RANGE: - 40° C to + 60° C (- 40° F to + 140° F).

RINGING TIME: 3 mi under typical conditions.

OTHER TESTS PERFORMED:

Transmitter Power Output

Spectrum Analysis

AFC Troubles

Pulse Length

Test for Erratic or Unstable Radar Operation

Transmitter Frequency Pulling

Automatic Frequency Control Checks

AFC Following

AFC Locking

T-R Box Recovery

Receiver Recovery

MAJOR COMPONENTS

QTY	ITEM	STOCK NUMBERS	DIMENSIONS (INCHES)	WEIGHT (LBS)
1	Cavity, Tuned FR-150/UP includes:			
1	Cable RG-9A/U			
2	Instruction Books			

4.2 FR-150/UP: 2

95

CAVITY, TUNED FR-150/UP

REFERENCE DATA AND LITERATURE:

MANUSCRIPT, TYPE II, CLASS 1, GRADE B: Instruction Book for Tuned Cavity FR-150/UP.

TUBE, CRYSTAL AND/OR SEMI-CONDUCTOR DATA:

TUBES: None required.

CRYSTALS: None required.

SEMI-CONDUCTORS: (1) 1N21BR (1) 1N23E

SHIPPING DATA

PKGS VOLUME (CU FT) WEIGHT (LBS)

PROCUREMENT DATA

PROCURING SERVICE: USN
SPEC &/OR DWG:

DESIGN COG: USN, BuShips

CONTRACTOR	LOCATION	CONTRACT OR ORDER NO.	APPROX. UNIT COST
Johnson Service Co.	Milwaukee, Wis.	N0bsr 81245	

20 April 1965

SWEEP GENERATOR SG-132

Cog Service: USN FSN:

Functional Class:

USA

USN

USAF

TYPE CLASS:

Used by

MANUFACTURER'S NAME/CODE NUMBER: Bay State Electronics Corporation, (11242).

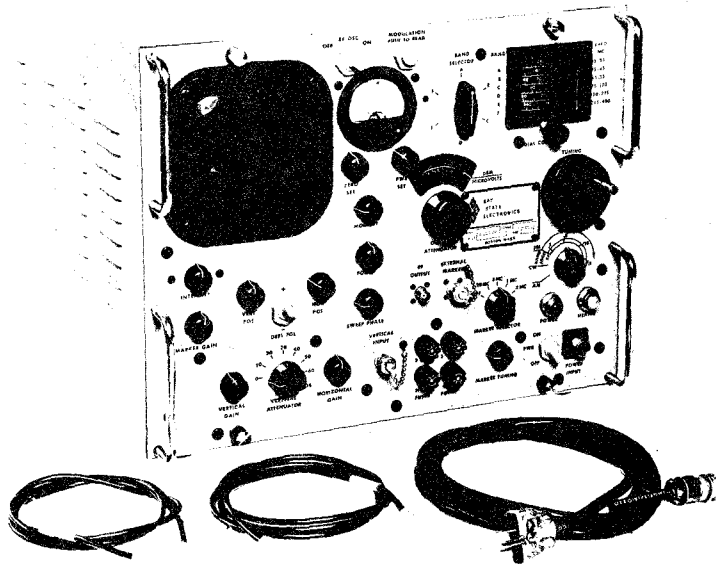

SWEEP GENERATOR SG-132

FUNCTIONAL DESCRIPTION:

Sweep Generator SG-132 is designed to provide low-power radio-frequency test signals in the frequency range of 15 to 400 megacycles, at a power level from 0.1 microvolt to 150,000 microvolts (equivalent to a range of 3 to 127 db below one milliwatt) when terminated in a 50 ohm load. The instrument provides continuous-wave, amplitude modulated, and frequency modulated output signals.

Specific uses of the equipment are measurements and tests in the following applications: (a) Testing and aligning VHF-UHF communication receivers; (b) Measuring sensitivity, selectivity, image rejection and gain of receivers, IF amplifiers, broadband amplifiers, TV, and other VHF-UHF equipments. Extremely low RF leakage and low-level receiver measurements; (c) Displaying bandpass curves of RF amplifiers, IF amplifiers, and RLC networks. Because the FM output is taken directly from an accurately calibrated piston type attenuator, gain and gain-bandwidth measurements can at last be made with ease. The Model SG-132 eliminates the

SWEEP GENERATOR SG-132

need for a second standard signal generator, since the unit produces an accurately known input signal. The sensitivity of the built-in oscilloscope allows direct observation of response curves, without the need for any preamplification.

No field changes in effect at time of preparation (29 October 1964).

RELATION TO OTHER EQUIPMENT: None.

EQUIPMENT REQUIRED BUT NOT SUPPLIED: None.

TECHNICAL CHARACTERISTICS:

FREQUENCY RANGE: 15 to 400 mc, covered in six bands.

POWER REQUIREMENTS: 103.5 to 126.5 v rms ac, 50 to 1000 cps, 210 W.

SWEEP DEVIATION

FM OPERATION: $\pm 1\%$ to $\pm 20\%$ of the ctr freq.

SWEEP RATE

FM OPERATION: 25 cps, $\pm 10\%$.

OUTPUT LEVEL VARIATION

FM OPERATION: Less than ± 0.25 db from ctr freq at any deviation control setting.

ACCURACY OF FREQUENCY CALIBRATION

AM AND CW OPERATION: $\pm 0.5\%$ w/the dial corrector set at mid-position ($\pm 0.01\%$) by use of int xtal marker generator.

DIAL CORRECTOR RANGE: ± 6.0 to ± 8.0 mc at 400 mc.

AMPLITUDE MODULATION: 400 cps $\pm 2\%$. Percent modulation continuously adjustable from zero to 50%; 30% modulation point indicated by red line on calibrated meter scale.

RF OUTPUT VOLTAGE: Continuously adjustable from 0.1 uv min to 150,000 uv max when operated into rated load at 50 ohms.

HARMONIC CONTENT: At least 40 db below desired signal.

SPURIOUS AMPLITUDE MODULATION: 0.5% max.

RESIDUAL FREQUENCY MODULATION: Less than 0.03% in AM modulation at 30% Modulation Level.

OUTPUT LEVEL CALIBRATION ACCURACY: Accuracy of attenuator dial is ± 1 db or better when connected to rated load.

RATED LOAD: Nominally 50 ohms resistive.

OUTPUT CIRCUIT STANDING WAVE RATIO: The VSWR measured at the output connector is less than 1.3 to 1 (SWR 2.5 db).

FREQUENCY MARKER SPACINGS: 200 kc, 1 mc, and 20 mc, $\pm 0.01\%$.

MARKER TIP AMPLITUDE: From zero to at least 1/2 in. total vertical displacement on Cathode-Ray tube screen.

CATHODE RAY TUBE: 5 in. screen, type 5UP1.

VERTICAL INPUT ATTENUATOR: Step type, w/seven ranges from zero to 60 db attenuation.

BANDWIDTH, OSCILLOSCOPE VERTICAL DEFLECTION AMPLIFIER: Max hf response of 15 kc at the 6 db points.

SWEEP GENERATOR SG-132

MAJOR COMPONENTS

QTY	ITEM	STOCK NUMBERS	DIMENSIONS (INCHES)	WEIGHT (LBS)
1	Sweep Generator SG-132 includes:			
1	Electrical Power Cable Assy		96	0.53
1	RF Coupler-Detector No. ACD-1		3/4 x 3-1/2 x 4	0.29
1	Impedance Matching Network No. AMN-1		3/4 x 3/4 x 3-1/8	0.16
1	Termination No. ATN-1		3/4 x 3/4 x 2-1/16	0.09
1	Fixed Attenuator No. AAT-1		3/4 x 3/4 x 3-3/8	0.16
1	Test Prod No. ATP-1		3/4 x 4-11/16	0.11
1	Test Adapter No. ATA-1		3/4 x 3/4 x 4	0.16
2	Cords		60	0.26
1	Connector Adapter UG-201/U		3/4 x 1-9/16	0.05
1	Connector UG-491A/U		9/16 x 1-5/16	0.05

REFERENCE DATA AND LITERATURE:

NAVSHIPS 94221: Handbook Operation and Maintenance Instructions for Sweep Generator SG-132.

TUBE, CRYSTAL AND/OR SEMI-CONDUCTOR DATA:

TUBES: (3) 6X4W (2) OB2WA (1) 5R4WGA (1) 2X2A (5) 6005/6AQ5W (6) 5654/6AK5W
(1) 6481/5767 (1) 0A2WA (6) 12AT7WA (3) 5814A (4) 12AX7 (1) 5751 (1) 5UP1

CRYSTALS: Not required.

SEMI-CONDUCTORS: (1) G7B (1) 1N81 (1) SD94A

SHIPPING DATA

PKGS	VOLUME (CU FT)	WEIGHT (LBS)
------	----------------	--------------

PROCUREMENT DATA

PROCURING SERVICE: USN
SPEC &/OR DWG:

DESIGN COG: USN, BuShips

CONTRACTOR	LOCATION	CONTRACT OR ORDER NO.	APPROX. UNIT COST
Bay State Electronics Corp.	Boston, Massachusetts	N600-24-60978	